

NOVUM LEAP™

PANAMA GREEN TD

PANAMA GREEN TD

Dual-purpose Chiller/Freezer

TECHNICAL SPECIFICATIONS







NOVUM

Redefining refrigeration

WWW.NOVUM.IE

TECHNICAL SPECIFICATION

		2 Door		3 Door	
Panama Green TD					
Technical Data		Frozen Mode	Chiller Mode	Frozen Mode	Chiller Mode
Gross content	litre	1667	1667	2500	2500
Net Content according to EN 23953	litre	1467	1467	2200	2200
Total Display Area (TDA) according to Eco-Directive	M ²	1.98	1.98	2.97	2.97
Classification according to EN 23953		3L1	3M1	3L1	3M1
Ambient Temperature Range	°C	+16 to +25	0 to +4	+16 to +25	0 to +4
Inner Temperature Range	°C	-18 to -25	-18 to -25	-18 to -25	-18 to -25
Sound Pressure at 1m Distance	dB(A)	46	46	48	48
Electrical Data					
Nominal Voltage / Frequency	V / Hz	220-240 / 50	220-240 / 50	220-240 / 50	220-240 / 50
Nominal Power Cabinet	w	967	967	1450	1450
Nominal Power LED Light	w	4 x 14	4 x 14	6 x 14	6 x 14
Nominal Current	A	4.0	4.0	6.3	6.3
Fuse Protection	A	13	13	13	13
Energy Consumption at 25°C	kWh/24h	13.73	7.18	20.6	10.77
Length of Power Supply Cord	mm	2000	2000	2000	2000
Refrigeration Data					
Refrigerant	Type	R290	R290	R290	R290
Gas Charge	g	2x 65	2x 65	3x 65	3x 65
Maximum Operating Pressure	bar	30	30	30	30
Maximum Heat Output	W/h (Btu/h)	1200	1200	1800	1800
Dimensions					
Length Outside/ Inside	mm	1548 / 1393	1548 / 1393	2300 / 2150	2300 / 2150
Depth Outside/ Inside	mm	950 / 723	950 / 723	950 / 723	950 / 723
Depth of shelves	mm	660	660	660	660
Number of shelves	mm	4	4	4	4
Weight					
Net Weight (excl. packaging, incl. internal accessories)	Kg	315	315	420	420
Gross Weight (incl. packaging & internal accessories)	Kg	338	338	450	450

Notes:

1. Specifications are subject to change without notice.
2. Case designed to operate in an ambient temperature of 25°C and relative humidity of 60% or lower
3. Wire shelf standard rated for max of 70kgs
4. Heavy Duty shelf option for "heavier loads"
5. 6 inch legs shipped loose
6. Hold over cases should only be loaded with pre-cooled or pre-frozen product

Panama Green TD External Dimensions - 3 Door

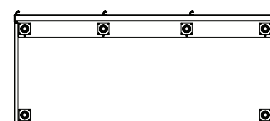
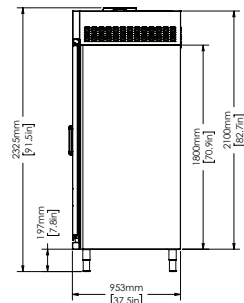
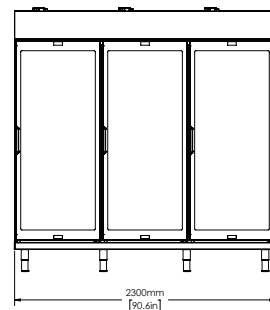
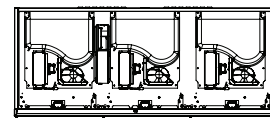
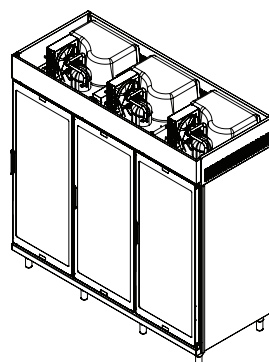

Panama Green TD Internal Dimensions

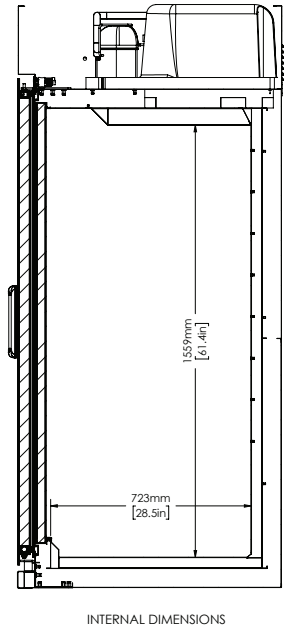
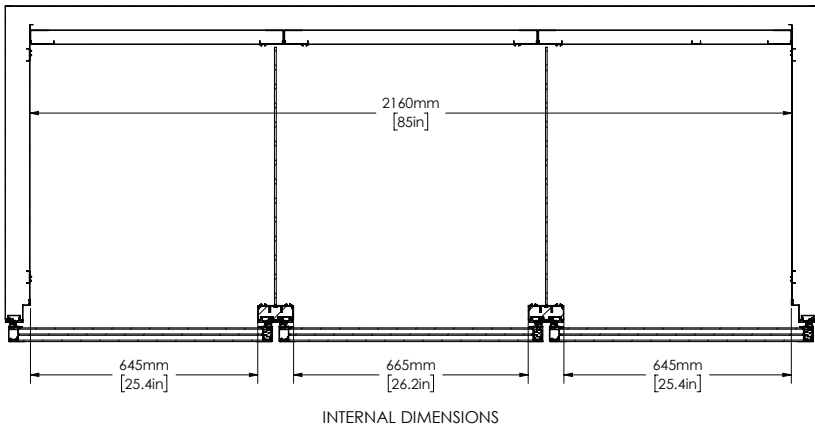
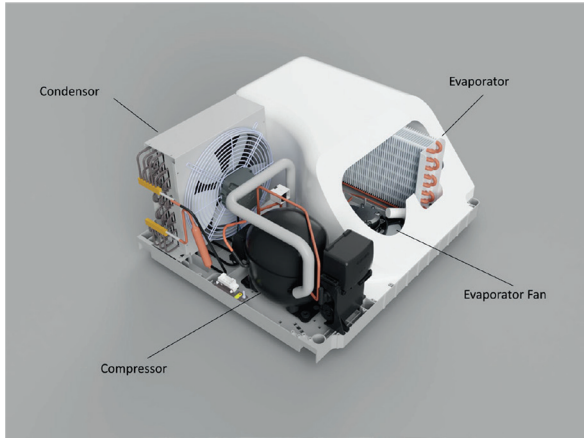

Panama Green TD External Dimensions - 2 Door

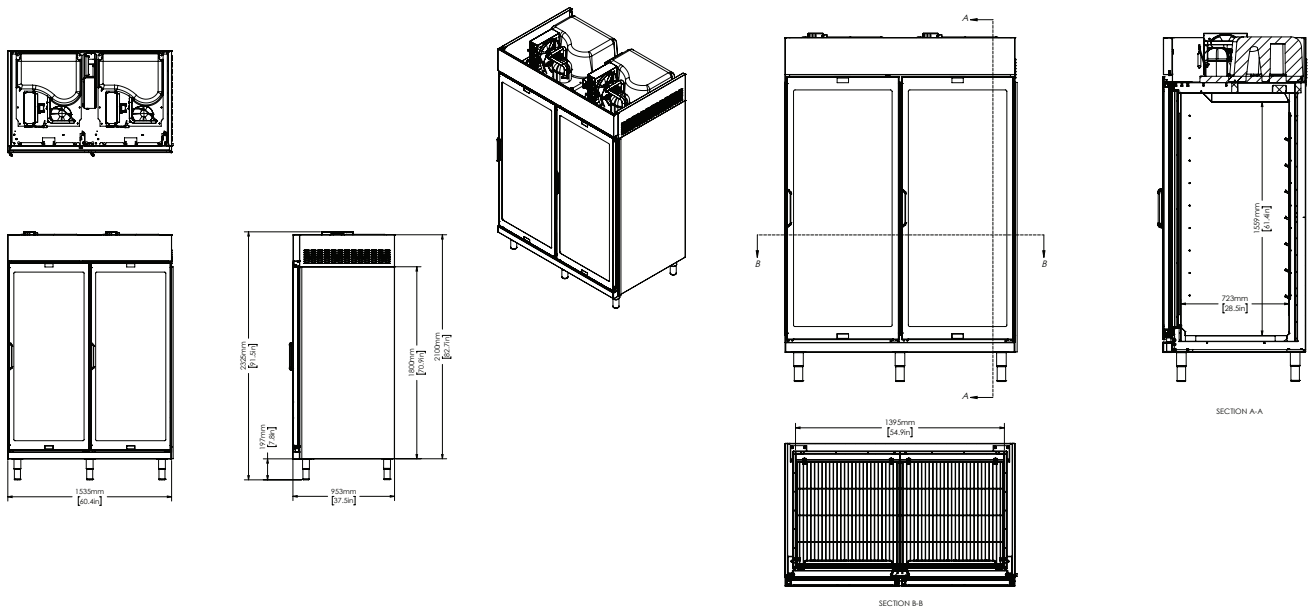

NOVUM LEAP™

PANAMA GREEN

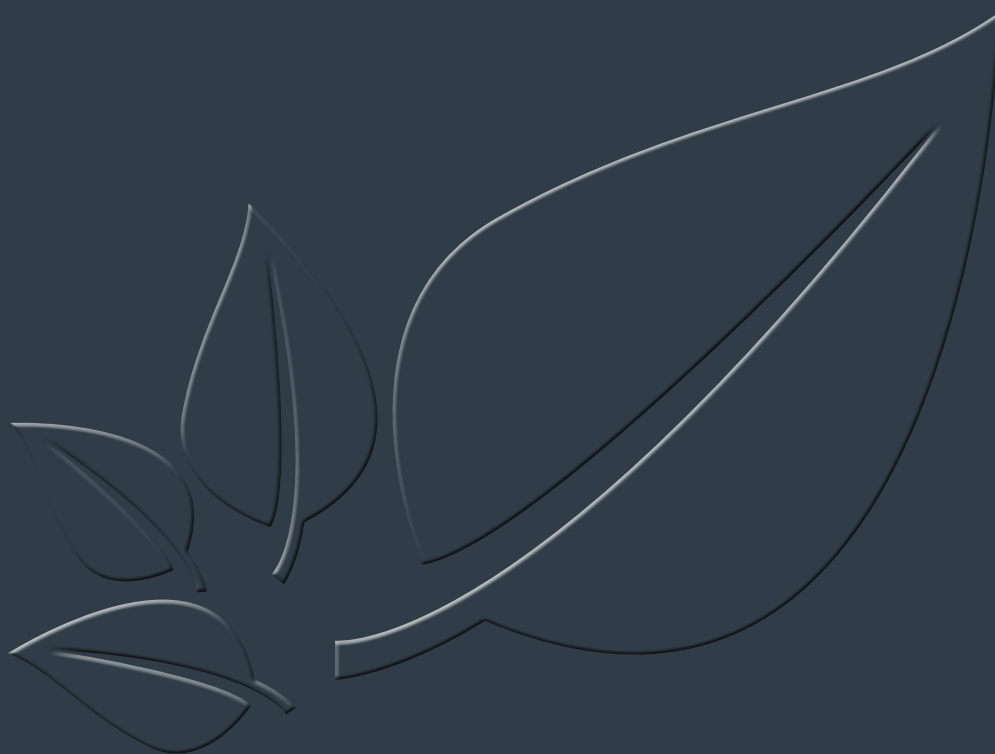

NOVUM

Redefining refrigeration

Novum (Overseas) Ltd.
The Novum Building
Clonshaugh Technology & Business Park
Dublin 17, Ireland

+353 1 803 6400
www.novum.ie